

WIRELESS CONTROL UNIT FOR CONTROL OF ELECTRIC HEATING DEVICES (WITHIN ONE ROOM)

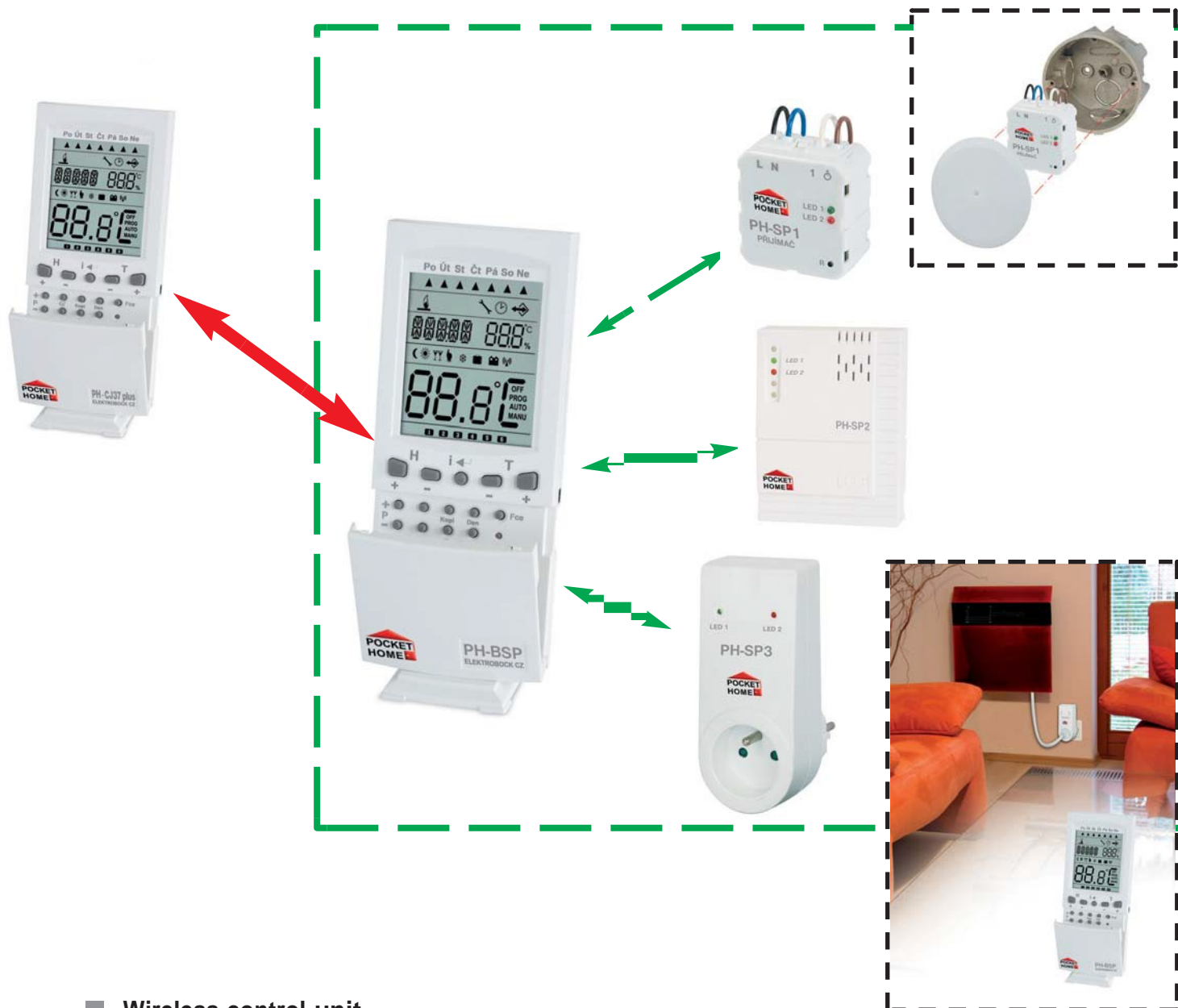

■ **Wireless control unit**

■ **Two-way radio communication on 433.92 MHz**

■ **Comfortable solution of room heating**

■ **Predictive system** (providing for the given temperature at the required time, in autonomous mode only)

■ **Energy cost saving during holiday**

■ **Control of room temperature according to preset requirements**

■ **Possibility of integration in the PocketHome® system, in which it becomes a subordinate element of the central unit PH-CJ37 / PH-CJ37 Plus**

SYSTEM FUNCTIONS

This wireless two-way system is primarily designed for the regulation of electric heating in a single room. Here, the control unit fulfills the of a wireless room thermostat. According to the temperature in the reference room, in which it is located, it controls the heat source (for example, a heating panel) and regulates the whole heating system according to the preset program. It enables control of up to 255 RECEIVERS (switching elements) from one place. The control unit sends information on the required temperature to individual components; on the basis of this information, each component controls the heating appliance to which it is connected. **PH-BSP switches the elements stepwise (at approx. 1s) to prevent current surges in the network!**

SYSTEM COMPONENTS

PH-BSP Wireless control unit

- measures temperature in the room and switches the individual heating devices centrally as required (functions as a room thermostat);
- able to control up to **255 switching elements** (PH-SP1, PH-SP2, PH-SP3) from one place;
- **switches the elements stepwise (at 1 s), thus preventing current surges in the network;**
- suitable for controlling electric heaters in one room;
- for control by means of a mobile phone, you just need to connect the GST1 / GST2 module (page 9, 12, 13);
- can be integrated in the PocketHome® system, in which it becomes a subordinate element of the central unit PH-CJ37/ PH-CJ37 Plus and meets its requirements.



PH-SP1 Wireless switch – under the switch

- switches the heating device on the basis of information received;
- sends back confirmation of the change made;
- simple installation into the installation box;
- receiver states are indicated by LEDs on the front panel;
- after short-time voltage failure, it activates automatically into the system (E-EEPROM memory)



PH-SP2 Wireless switch – wall-mounted

- switches the heating device on the basis of information received;
- sends back confirmation of the change made;
- simple installation on the installation box;
- receiver states are indicated by LEDs on the front panel;
- after short-time voltage failure, it activates automatically into the system (E-EEPROM memory).



PH-SP3 Wireless switch – socket-mounted

- switches the heating device on the basis of information received;
- sends back confirmation of the change made;
- simple installation in the socket directly;
- device connected by simply inserting it into the socket (suitable for heaters with plug outlet);
- receiver states are indicated by LEDs on the front panel;
- after short-time voltage failure, it activates automatically into the system (E-EEPROM memory).



- ! In order to prevent interference and affecting of the systems, each of them is protected by its own unique code which is stored in the control unit PH-BSP by the manufacturer!
- ! Correct communication of all system components with the control unit PH-BSP requires code learning - ACTIVATION of each component added to the system!
- ! As the whole system works at bidirectional radio frequency of 433.92 MHz, observe the instructions for installation and location of each system component according to the given manual!

PERMEABILITY OF VARIOUS MATERIALS FOR RF SIGNAL 433.92 MHz

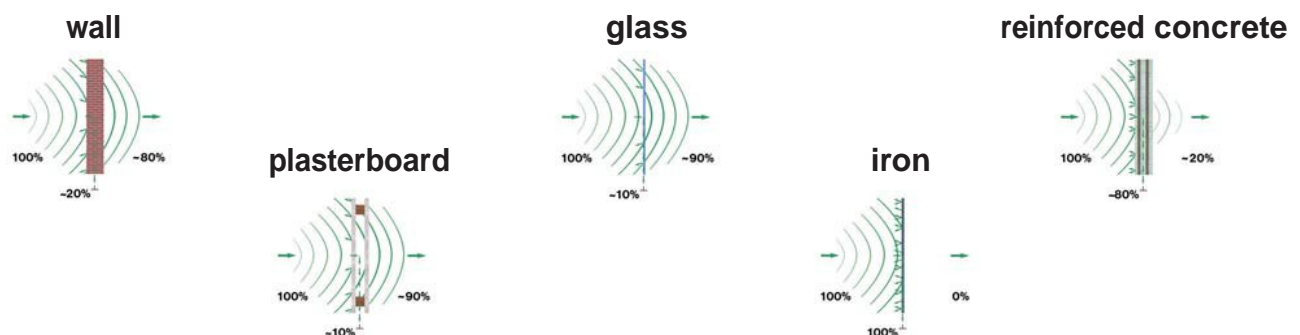

Note: The above mentioned values are only approximate; they may vary because of specific conditions at the location of signal transmission and reception!

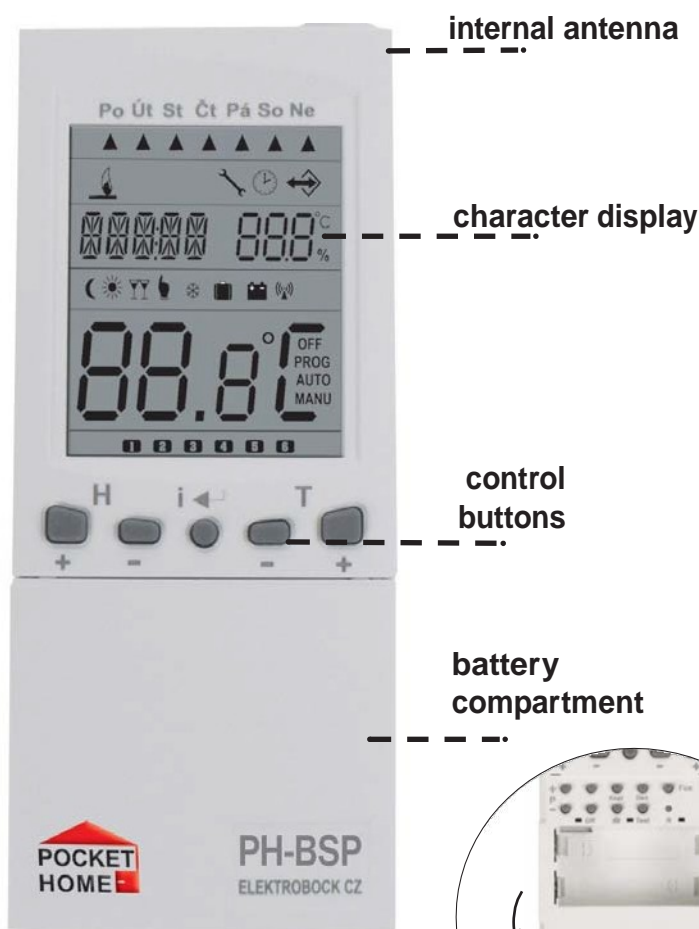

We recommend you to use the external source (AD05) if the system contains more than 10 elements!

Connector for external source
(5 to 12V/ DC min. 150 mA)

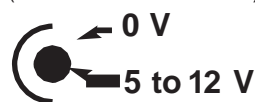

connector for GST module

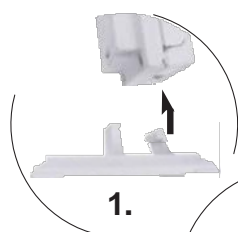

stand installation



3.

Note: The stand is supplied with PH-BSP



Note: The external source and GSM modules are not included in PH-BSP!

LOCATION OF BATTERIES AND THEIR REPLACEMENT

- Open the battery compartment cover and remove the protective paper; now PH-BSP is functional.
- When replacing batteries, pay attention to correct polarity, as shown in the battery compartment.
- Low battery is indicated by the  symbol flashing on the display.
- Use solely alkaline pencil-type batteries 2x1.5 V, AA type!

! Dispose of old batteries in compliance with the regulations related to the handling of dangerous waste!

DESCRIPTION OF CONTROLS ON PH-BSP

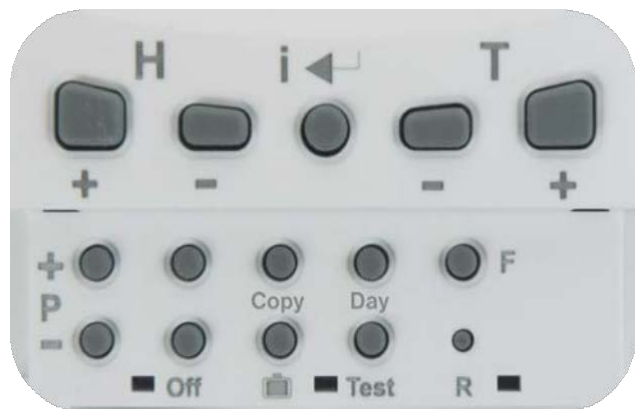

	change of time (in PROG mode) setting the date and time (in holiday mode “”)
	browsing among elements (in ACTIV and INFO mode) enter (confirmation)
	shift for setting the constant 17 – phone. No. (in CONST mode)
	change of temperature change in the setting of clock and constants
	copying of days (in PROG mode)
	change of day (in PROG mode)
	selection of function (mode), see p.6 AUTO, MANU, CLOCK, PROG, CONST, ACTIV, INFO, UAdr
	reset of operating hours component deactivation (in ACTIV mode) switching all components off (in AUTO, MANU mode)
	testing of correct connection (of receiver, GSM module); testing of individual components (in ACTIV, INFO modes)
	reset

	selection of program for boiler (in AUTO mode) switching between programs (in PROG mode) switching between constants (in CONST mode) switching between temperatures “ and ” (in MANU mode) component adding (in ACTIV mode)
	reset of operating hours component deactivation (in ACTIV mode) switching all components off (in AUTO, MANU mode)
	change of day (in PROG mode)
	selection of function (mode), see p.6 AUTO, MANU, CLOCK, PROG, CONST, ACTIV, INFO, UAdr

	copying of days (in PROG mode)
	holiday (in this mode, info cannot be displayed) selection of EVEN/ODD week (in PROG mode)
	testing of correct connection (of receiver, GSM module); testing of individual components (in ACTIV, INFO modes)
	reset

DESCRIPTION OF THE PH-BSP DISPLAY

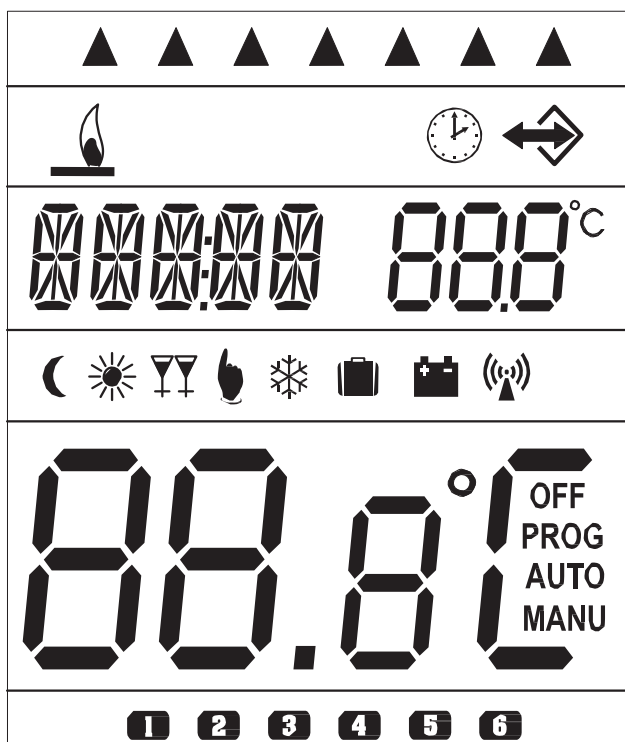

	current day indication
	switch-on indication
	symbol of current date and time setting, see page 6
	indication of active communication
	variable part of the display, indication of current time and required temperature / program number, indication of other information is explained in detail with every mode
	economy temperature indication (in MANU mode)
	summer mode symbol, see page 8
	comfortable temperature indication (in MANU mode)
	error message, error notice
	anti-freeze mode symbol, see page 11
	holiday mode symbol, see page 11
	low battery indication
	signal transmission / reception indication
	variable part of the display, indication of current temperature and selected mode (OFF, AUTO, MANU, PROG), indication of other information is explained in detail with every mode
	program interval indication (max. 6 intervals per day)

ACTIVATION PROCEDURE IN THE PocketHome® SYSTEM

After PH-BSP activation in the PocketHome® system, the control unit will be controlled by the central unit PH-CJ37(Plus). On the basis of the temperature measured in the room and the information received (on the temperature required) from the central unit, switching elements will be controlled (of the PH-SP1/PH-SP2/PH-SP3 receivers).

Note: The activation can also be done via a PC. Connect the PH-CJ37(Plus) to the PC and start the PocketHome® software; follow the instructions for the software.

1. PH-BSP ACTIVATION

- Add the new bSP element in the central unit PH-CJ37(Plus) (ACTIV, page 12, in the central unit instructions), including the temperature program.
- Press the **F** button on the PH-BSP unit, and choose the **UAdr** mode with the **+/- T** buttons and confirm by **i←** button.
- Press the **Test** button on PH-CJ37(Plus); the central unit sends a signal to PH-BSP
- After correct signal is received, PH-BSP displays the unique number of the central unit and the address allocated.
- Within 2 minutes, the central unit sends repeated signals to PH-BSP; or if you press the **Test** button to speed up the communication.
- PH-BSP displays the **bEZ:dr** message and the unit is fully controlled by the PH-CJ-37(Plus) central unit.

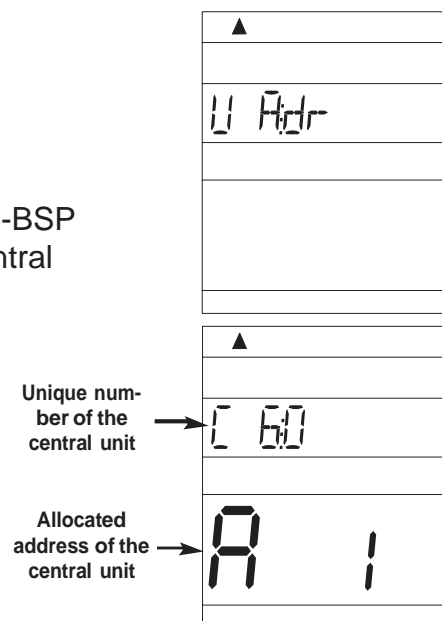

Indication of the BSP unit state in the PocketHome® system

State**	Description
ON	AUTO and MANU are simultaneously shown on the display
VYPNUTO	AUTO and MANU are simultaneously flashing on the display

2. SETTING OF PH-BSP CONTANTS

Follow the instructions on page 8. CONST3, CONST17 to CONST19 will not be displayed in this mode (they are set in the central unit PH-CJ37(Plus)).

3. ACTIVATION OF SWITCHING ELEMENTS

Follow the instructions on page 10. **Do not set the program for switching elements, the required temperature is transferred from PH-CJ37(Plus).**

WHAT YOU NEED NOT SET?

- 1) TIME - If the time is changed in PH-CJ37(Plus), it will automatically be transmitted; PH-CJ37(Plus) shows the "bSP" message shortly, and the time will be synchronized.
 - 2) PROGRAMS - programs are not set on PH-BSP, since you can choose it on PH-CJ37(Plus) directly.
- Other automatic functions:**
- 3) Boiler state message – twice an hour, PH-CJ37(Plus) sends information on the boiler state to all elements ("bSP" is displayed again), and the "t : Hr" message (e.g. general test) appears on PH-BSP.

In connection with the central unit, PH-BSP is a subordinate element. The required temperature is received from the central unit (the AUTO mode is not accessible on PH-BSP).

A short-time temperature change in the room in which PH-BSP is located can be made with the +/- T button on PH-BSP directly, but only until the next program change in the central unit!

ACTIVATION PROCEDURE IN THE AUTONOMOUS MODE

PH-BSP can work as an independent control unit which controls switching elements within one room. This mode is autonomous – independent of the central unit PH-CJ37(Plus). This mode is suitable for heating within one room. For the setting, see below.

DESCRIPTION OF PH-BSP FUNCTIONS AND THEIR SETTING

Make sure you have carefully studied the introductory part of the instructions with the description of the unit, battery location, functions of buttons and symbols on the display (LCD)!

The next part is focused on explanation of basic modes and setting of important parameters for correct function of the entire system.

Press the **F** button and by means of the **+/- T** buttons browse the individual modes, confirm the mode selection by pressing the **i←** button.

AUTO automatic mode (not accessible in the PH system)

The system functions in automatic mode according to the program preset.

Change of the program is made by pressing the **+/- P** button.

Following information is displayed when **i←** button is pressed:

- required temperature; short-term change of the temperature can be made by pressing the **+/- T** button (page 11)

- operating hours; pressing the **Off** button resets the counter

Display options on LCD:

line 1 - current day

line 3 - from the left: current time or error states, required temperature or program number

line 5 - current temperature and selected mode

line 6 - program interval

1.1	▲
1.2	
1.3	AUTO
1.4	
1.5	AUTO
1.6	

MANU manual mode

The system functions in the manual mode.

VWithin this mode, two required temperatures may be set: the economy **☾** and comfortable **☿☿**. Selection and setting are made with the **+/- P** and **+/- T** buttons.

Display options on LCD:

line 1 - current day

line 3 - from the left: current time or error states, required temperature

line 4 - selected temperature: economy **☾** or comfortable **☿☿**

line 5 - current temperature and selected mode

▲
MANU
MANU

CLOCK setting of current time and date

By means of the **+/- T** buttons, successively set hours, confirm by pressing **i←** button; minutes, confirm by pressing **i←** button; seconds, confirm by pressing **i←** button; day, confirm by pressing **i←** button; month, confirm by pressing **i←** button; and year, confirm by pressing **i←** button.

▲
🕒
CLOCK

PROG programming

The control unit fulfils the functions of a room thermostat and enables setting of up to 9 different weekly programs.

For each day, up to 6 time intervals can be set with various temperatures.

Upon first activation, programs 3-9 are set by default (can also be changed).

In program 1 and 2, you can set even and odd weeks, which will change automatically according to requirements (page 7).

! After activation of PH-BSP in the PocketHome® system, programs cannot be changed; requirements are directly sent from the central unit PH-CJ37(Plus).

▲
PROG
PROG

Direct programming on PH-BSP

- Press the **F** button and select the **PROG** mode by means of the **+/- T** buttons; confirm by pressing the **i←** button.
- By pressing the **+/- P** buttons, select the program, which should be set (1.P to 9.P).
- Press **+/- H** buttons to set the beginning of the temperature change, with the minimum step of 10 minutes.
- Assign the required temperature to the given time by pressing the **+/- T** buttons by steps of 0.5 °C.
- After setting the first time and temperature, press the **i←** button to confirm.
- You are automatically shifted to setting of the second time and temperature for the same day, as indicated by symbol **2** on the last, sixth line of the display.
- Continue in the same way until you set the last (sixth) interval.
- By pressing the **i←** button, you will automatically move to the setting of the next day, where you can proceed in the same way.

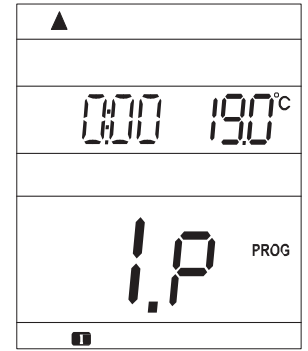

Info: If not all of the 6 settings for one day are needed, it is possible to move to the next day by successively pressing the **i←** button or the **Day** button.

Copying of days in PROG mode

This function accelerates programming. Program for one day can be copied to the next day by simply pressing the **Copy** button.

- The day indicator must be on the day which you want to copy to the next day.
- Press the **Copy** button, the program will copy itself automatically to the next day and the day indicator (line 1 of the display) moves to the next day.

Selection of even or odd week in PROG mode

If you have set programs 1.P and 2.P, you can define which one will be active in odd or even weeks. When this option is selected, the programs will alternate each week in the **AUTO** mode automatically (suitable for work in shifts).

- Press the **F** button and select the **PROG** mode by means of the **+/- T** buttons; confirm by pressing the **i←** button.
- By pressing the **+/- P** buttons, select program **1.P**
- Press the **■** button and specify the week in which the program will be active: **L = odd, U = even, 1 = not defined**
- program **2.P** will be defined automatically.

ODD

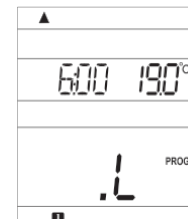

EVEN

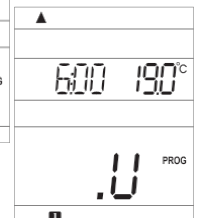

Pre-set factory programs

Programs **3.P to 9.P** are factory pre-set, but can be changed as necessary like 1.P and 2.P. (example: item 5/21 means that at 5 o'clock, the required temperature is 21°C)

Note: When changing the preset programs, check all of the 6 time intervals!

program No.3	1	2	3	4	5	6
Monday	05/21	06/18	12/20	16/21	18/22	21/18
Tuesday	05/21	06/18	12/20	16/21	18/22	21/18
Wednesday	05/21	06/18	12/20	16/21	18/22	21/18
Thursday	05/21	06/18	12/20	16/21	18/22	21/18
Friday	05/21	06/18	12/20	16/21	18/22	21/18
Saturday	07/21	21/18				
Sunday	07/21	21/18				

program No.4	1	2	3	4	5	6
Monday	06/21	07/18	15/21	18/22	22/18	
Tuesday	06/21	07/18	15/21	18/22	22/18	
Wednesday	06/21	07/18	15/21	18/22	22/18	
Thursday	06/21	07/18	15/21	18/22	22/18	
Friday	06/21	07/18	15/21	18/22	22/18	
Saturday	07/21	18/22	22/18			
Sunday	07/22	18/23	22/19			

program No.5	1	2	3	4	5	6
Monday	08/21	09/18	15/21	18/22	23/18	
Tuesday	08/21	09/18	15/21	18/22	23/18	
Wednesday	08/21	09/18	15/21	18/22	23/18	
Thursday	08/21	09/18	15/21	18/22	23/18	
Friday	08/21	09/18	15/21	18/22	23/18	
Saturday	08/21	18/22	22/18			
Sunday	08/21	18/22	22/18			

program No.6	1	2	3	4	5	6
Monday	07/21	09/18	15/22	18/23	22/18	
Tuesday	07/21	09/18	15/22	18/23	22/18	
Wednesday	07/21	09/18	15/22	18/23	22/18	
Thursday	07/21	09/18	15/22	18/23	22/18	
Friday	07/21	09/18	15/22	18/23	22/18	
Saturday	07/21	18/23	22/18			
Sunday	07/21	18/23	22/18			

program No.7	1	2	3	4	5	6
Monday	07/22	09/18	15/23	18/24	22/18	
Tuesday	07/22	09/18	15/23	18/24	22/18	
Wednesday	07/22	09/18	15/23	18/24	22/18	
Thursday	07/22	09/18	15/23	18/24	22/18	
Friday	07/22	09/18	15/23	18/24	22/18	
Saturday	08/22	18/24	22/18			
Sunday	08/22	18/24	22/18			

program No.8	1	2	3	4	5	6
Monday	06/20	08/18	14/21	17/22	22/17	
Tuesday	06/20	08/18	14/21	17/22	22/17	
Wednesday	06/20	08/18	14/21	17/22	22/17	
Thursday	06/20	08/18	14/21	17/22	22/17	
Friday	06/20	08/18	14/21	17/22	22/17	
Saturday	07/21	17/23	22/19			
Sunday	07/21	17/23	22/19			

program No.9	1	2	3	4	5	6
Monday	08/23	21/18				
Tuesday	08/23	21/18				
Wednesday	08/23	21/18				
Thursday	08/23	21/18				
Friday	08/23	21/18				
Saturday	08/23	21/18				
Sunday	08/23	21/18				

CONST setting the constants

For correct thermostat function of the control unit, you must set the following constants which define, for example, the temperature limits or method of control (hysteresis or PI regulation).

- press **F** button and by means of **+/- T** select **CONST** mode, confirm by pressing **i←**.
- press **+/- P** buttons to display individual constants (see below).
- set by pressing **+/- T** buttons, again confirm by **i←** button.

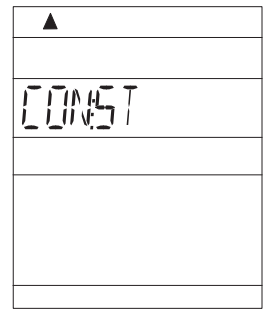

1. MINIMUM REGULATED TEMPERATURE

Here you set the limits of the minimum adjustable temperature. You can select in the range from **2° C to 10 °C**.

Make the setting and press the **i←** button to move to the next constant setting automatically.

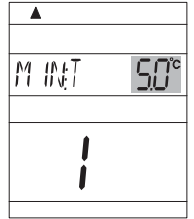

2. MAXIMUM REGULATED TEMPERATURE

Here you set the limits of the maximum adjustable temperature. You can select in the range from **15° C to 39 °C**.

Make the setting and press the **i←** button to move to the next constant setting automatically.

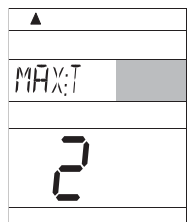

3. EARLY SWITCH-ON OF THE HEATING SYSTEM / SUMMER MODE (in autonomous mode only)

By pressing **+/- T** buttons, select one of the following modes and confirm by pressing the **i←** button (! If PH-BSP is controlled by the central unit, this constant is not shown).

Option 0 = normal mode

Normal operation of the heating system, without early switch-on of the heating.

Option 1 = early switch-on of the heating

This function guarantees you the required temperature at the required time.

You need not guess when to switch the heating on in order to have the adequate temperature in the morning when getting up without heating long in advance unnecessarily. You only program the time of the required temperature. In two days of operation, PH-BSP establishes the thermal constants of the room and then switches the heating on at the required time in advance. **The early switch-on period is limited to 2 hours.**

Option 2 = summer mode

In this mode, the heating cannot be switched on. It is useful especially in the summer period, when heating is not necessary. When this mode is activated, the "☀" symbol appears on the display.

Note: The anti-freeze protection (3°C) is still functional. **In this mode, it is not possible to change the temperature and set the holiday mode!**

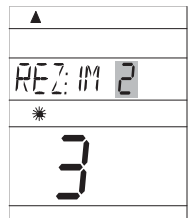

9. MINIMUM SWITCH-ON TIME OF THE HEATING APPLIANCE AT HYSTERESIS

Here you set the minimum time of switching the boiler on at hysteresis.

Select according to the type of the heating system used, see the table.

Type of heating	Minimal period of source activation
electrical heating	1
panel radiators	2 (3)
cast-iron radiators	4
floor heating	5

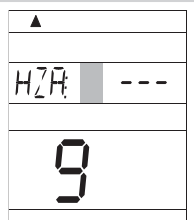

10. SELECTION OF HYSTERESIS OR PI REGULATION

By pressing the **+/- T** buttons, set the **hysteresis** from **0,1°C to 1,5°C**.

If hysteresis is selected, the constants (11, 12, 13), related to the settings of PI regulation parameters, are omitted automatically.

If you select three horizontal dashes with the **+/- T** buttons, **PI regulation** is active.

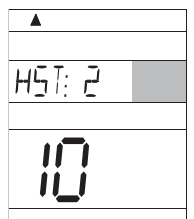

11. TIME INTERVAL OF PI REGULATION

This can be set in the range from **5 to 20 minutes**. The length of this interval is given by thermal inertia of the room.

The optimum setting is 10 to 15 minutes.

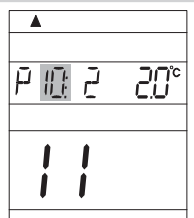

12. MINIMUM SWITCH-ON TIME OF THE HEATING APPLIANCE AT PI REGULATION

This can be set in the range from **1 to 5 minutes**.

The setting is given by the type of the heating system, and depends on the PI regulation time interval selected.

The table settings are recommended.

Type of heating	Minimal period of source activation
electrical heating	1
panel radiators	2 (3)
cast-iron radiators	4
floor heating	5

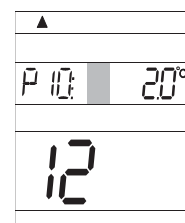

13. PROPORTIONAL BAND AT PI REGULATION

This parameter defines the value at which the PI regulation is activated.

For example, the required temperature is 22.0 °C and the proportional band is 1.5 °C.

Up to 20.5 °C, the source will heat with a full output. As soon as this value is achieved, PI regulation starts to function.

The PROPORTIONAL band can be set in the range from **1.5 to 3.0 °C**.

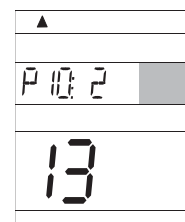

17. SELECTION OF CONTROL VIA GSM MODULE (in autonomous mode only)

By means of this constant, you can select the option to control the central unit via GSM module.

Options:

GSM: N GSM module is not enabled, **constants 18 and 19 are automatically omitted.**

GSM: A GSM module is enabled, **it is necessary to set the constants 18 and 19!**

Select by pressing the **+/- T** buttons and confirm by the **i ←** button.

(The control via GSM module is described in detail in the manual for GST1/GST2)

! After activation of PH-BSP in the PocketHome® system, this constant is not displayed!

(The GSM module controls the central unit PH-CJ37/Plus).

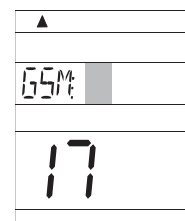

18. SETTING THE TELEPHONE NUMBER (in autonomous mode only)

This constant can only be set for the version with the option of connecting the GST1/GST2 module enabling the control via mobile phone (see p. 12-13).

Set the telephone number in international format (e.g. 420123456789), to which SMS messages informing about the thermostat condition should be sent.

Set by pressing the **+/- T** buttons and confirm by the **i ←** button.

You can browse the numbers with the **+/- H** buttons.

! After activation of PH-BSP in the PocketHome® system, this constant is not displayed!

(The GSM module controls the central unit PH-CJ37/Plus).

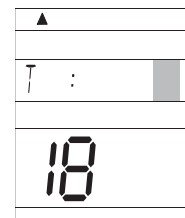

19. SETTING THE PIN CODE OF THE SIM CARD USED (in autonomous mode only)

This constant can only be set for the version with the option of connecting the GST1/GST2 module enabling the control via mobile phone (see p. 12-13).

Set the PIN code of the SIM card inserted in the GST1/GST2 module.

Set by pressing the **+/- T** buttons and confirm by the **i ←** button.

You can browse the numbers with the **+/- H** buttons.

! After activation of PH-BSP in the PocketHome® system, this constant is not displayed!

(The GSM module controls the central unit PH-CJ37/Plus).

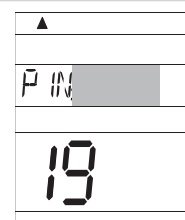

20. FIRMWARE VERSION

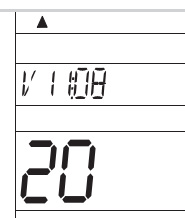

This constant cannot be set, it just informs you on the firmware version.



ACTIV activation of switching elements

This mode enables you to add (activate) successively the system components and assign temperature programs to them.

The maximum number of all the system components is 255!

- Press the **F** button and select the **ACTIV** mode by pressing the **+/- T** buttons; confirm by pressing the **i←** button.
- The option for program selection for the switching element **PROGR** appears on the LCD.
- Assign the 1.P to 9.P program with the **+/- T** buttons and confirm with the **i←** button.
- In the next step, activate step-by-step the SP1 to SP255 switching elements.
- Press the **+/- P** button, in which way you define the address of the first switching element (SP : 1) (the number in line 5 informs you about the total number of active elements).
- Press the **FUNCTION BUTTON** on the switching element (receiver) (for approx. 5 s); thus you enter the code learning mode (see the pertinent receiver instructions).
- Press the **Test** button on PH-BSP (the signal transmission symbol  appears as well as the symbol  of communication with the element).
- Two diodes flash simultaneously on the switching element; thus the element is **ENABLED!** If Err appears on the display of PH-BSP, you must check the connection and repeat the procedure!
- Add the next element with the **+/- H** button; the **+/- P** button defines the address of the second element (SP : 2); then repeat the procedure as during the activation of the first element.

If the **UCENI** message appears on PH-BSP, some of the elements have not been enabled correctly! Choose the switching elements step-by-step and test them with the **Test** button. If the Err message appears with an element, enable it again according to the above procedure.

total number of active elements

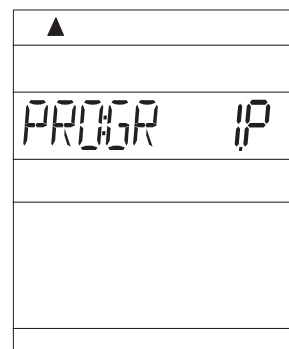
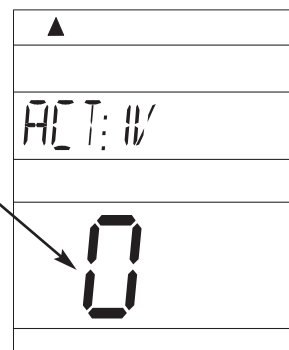

element address (sequence number)

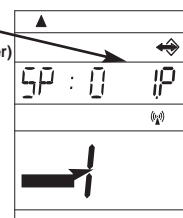

BROWSING the elements

- You can browse the individual elements with the **+/- H** button.

DISABLING of an element

- You can disable the element with the **Off** button.

INFO information on individual components activated within the system

In this mode, you can obtain information on the condition of individual system components.

- Press the **F** button and select the **INFO** mode with the **+/- T** buttons; confirm by pressing the **i←** button.
- Information on the selected program **PROGR (*)** appears on the display
 1. By pressing the **+/- T** button, you can change the temperature for the given mode.
- If you press the **i←** button, information on the SP: 1 switching component appears on the display
 1. required temperature;
 2. selected mode (AUTO, MANU);
 3. preset program.
- By pressing the **Test** button, you can check the device condition - HEATING/ NOT HEATING.
- Information on other components can be obtained by pressing the **+/- H** button.

total number of components of the whole system

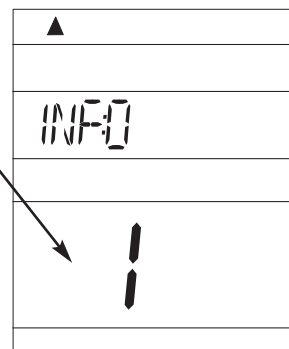

*** If PH-BSP is activated in the PocketHome® system, the program number is not displayed (the required temperature from the central unit is displayed).**

UAdr activation in the PocketHome® system (see page 5)

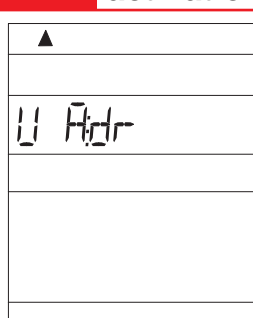

- Add the new BSP component in PH-CJ37/Plus (ACTIV, page 12 in the central unit instructions).
- On the PH-BSP unit, press the **F** button and select the **UAdr** mode with the **+/- T** buttons.
- Confirm with the **i←** button.
- Press the **Test** button on PH-CJ37.

If the activation was correct, the unique number and assigned address appear on PH-BSP. PH-BSP becomes a subordinate unit, waiting for orders from the central unit!

central unit unique number

address assigned by the central unit

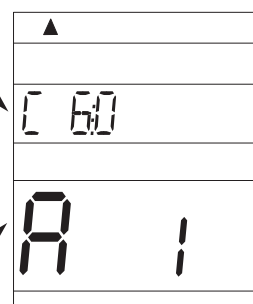



FURTHER FUNCTIONS



HOLIDAY (in autonomous mode only)

This function is very useful at the holiday time when the house is empty and it is not necessary to change the temperature.

Always set the DATE and HOUR of your return from holiday, when you want PH-BSP to return to the defined program (in AUTO or MANU)!

- Select AUTO or MANU mode
- Press the  button.
- By pressing the +/- H buttons, set the date of return from holiday and confirm by pressing the  button.
- Set the time of return and again confirm by pressing the  button.
- By pressing the +/- T buttons, set the temperature which will be kept throughout your holiday until you come back.
- After approx. 30 seconds, the central unit switches to the holiday mode.

PH-BSP shows the end date of your holiday, the required temperature and current temperature.

- ! In this mode, the buttons are not functional (with the exception of Off and )!
- This mode can only be cancelled by pressing the  button!

This mode **cannot be selected in SUMMER mode** (constant 3 is set, symbol )!

If PH-BSP is activated in the PocketHome® system, the holiday is directly set on the central unit PH-CJ37/Plus!

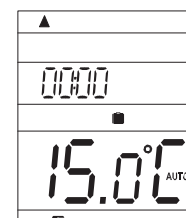

SHORT-TERM TEMPERATURE CHANGE IN AUTO MODE

This function can be used if the current room temperature does not suit you at the moment and you need to change it for a short time without any change to the program.

This function is possible in the **AUTO** mode; by simply pressing the +/- T buttons, set a temperature different from that specified in the program.

PH-BSP will maintain this temperature until the next change specified in the program.



RESET

The **R** button can only be used in case of an indefinable error - when pressed, the processor is reset, but all the changes made will remain stored in the E-EPROM memory!

To reset all of the parameters and programs defined (programs 3 to 9 will return to factory settings), press the **Off** and **R** buttons, release the **R** button, and then the **Off** button (the RESET message appears shortly on the LCD).

ANTI-FREEZE MODE

If the room temperature drops under 3 °C, PH-BSP automatically sends a command to switch the boiler on. As soon as the temperature increases, it returns back to the preset mode.

CONNECTION OF GST1/GST2 MODULE (cannot be used if PH-BSP is controlled by the central unit!)

The system can be extended with the GSM module - GST1/GST2, which provides for remote control of the control unit via a mobile phone. By means of simple SMS messages, you can control the heating or obtain information on the system condition. For detailed instructions, see the GST1/GST2 module (the module connection option is selected by CONST 17-19, page 9).

DESCRIPTION OF SETTINGS IF THE GSM MODULE IS USED

FOR CORRECT PUTTING INTO OPERATION, THE FOLLOWING PROCEDURE MUST BE OBSERVED!

1. Make installation and setting of the control unit according to the instructions.

2. Constants 17, 18 and 19 must be set on the control unit as follows:

SELECTION OF CONTROL VIA GSM MODULE - CONST 17

By pressing the +/- T buttons, select the GSM: A option and confirm with the i ← button.

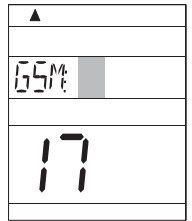

SETTING THE TELEPHONE NUMBER - CONST 18

Set the telephone number, in the international format (e.g. 420123456789), to which SMS return messages informing about the thermostat condition should be sent.

Set by pressing +/- T buttons and confirm with the i ← button.

You can browse the numbers set with the +/- H buttons.

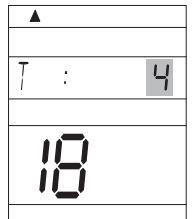

SETTING THE PIN CODE OF THE SIM CARD - CONST 19

Set the PIN code of the SIM card inserted in the GST1/GST2 module.

Set by pressing the +/- T buttons and confirm with the i ← button.

You can browse the numbers with the +/- H button.

Thanks to this function, you need not remember the PIN code of the SIM card inserted in the module connected to control unit. After entering the PIN code (according to the below procedure) in the control unit, connect the module and then connect it to the mains. Within approx. 3 minutes, the PIN code is automatically sent from the control unit to the module, thus the module becomes active (to accelerate the activation, use the Test button on the control unit).

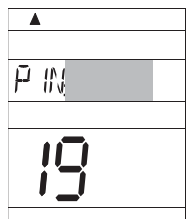

3. Insert the activated SIM card into the GST1/GST2 module. For more details, see the GST1/GST2 instructions.

4. Interconnect the control unit and the module by means of a data cable (included in the GST1/GST2 packing), and then connect the module supply unit to the 230 V / 50 Hz mains (the orange LED is flashing)!

5. As soon as the orange diode on GST1 is alight, test the correct connection by pressing the Test button on the control unit. One of the following messages appears on the display of the control unit (the connection is always automatically established within 3 minutes):

Signalizes correct connection of the module.



The module is not connected, incorrect connection of the module!



Signalizes correct connection of the module and PIN code setting.



Signalizes correct connection of the module, but incorrect PIN code setting! It is necessary to disconnect the module, RESET the control unit and set the correct PIN code!



WORDING OF MESSAGES SENT

Info SP	Information on the control unit condition
Temp xx SP	Change of the required temperature (where xx must be an integer within the range of admissible maximum and minimum temperatures).
Off SP	Switching the SP components off. To abolish the function, use the Temp xx SP message (if in the AUTO mode, the state is valid until the next program change).
Call	Back call

xx = temperature value in°C (always a two-digit number, e.g. 05)

- ! Any type of mobile phone can be used for sending and receiving of return messages!!
 If font size (format) can be adjusted in the phone, always use the **MEDIUM** size for messages (when three sizes are available) or the **LARGE** (when two sizes are available).

WORDING OF RETURN MESSAGES FROM THE CONTROL UNIT

Requir: xx.x	required temperature (entered by the user)
Act: xx.x	current temperature in the room
On	heating system on
Off	heating system off
AUTO	automatic mode AUTO
MANU	manual mode MANU
Sig: x	defines signal strength at the place of the module location; where x are values ranging from 0 to 5: 0..cannot be determined or no signal detected 1..the worst strength 5..the best signal strength
Battery!	signalizes a discharged battery in the central unit
Incorrect SMS or can not be identified selected device	incorrect SMS message or communication error

xx.x = temperature in°C

RETURN MESSAGES ARE SENT WITHIN 3 MINUTES!

Note: If the min/max room temperature is exceeded (as set by CONST1 and 2, see the PH-BSP manual, page 9), the "WARNING" SMS message same as Info is automatically sent immediately.

Info: If a pre-paid card is used, it is necessary to make a paid call once in three months. This call is made automatically (every 80 days, between 16 and 21 o'clock) to the number entered in the control unit (CONST 18), and after 20 s, the call is terminated automatically. By means of the "Call" SMS message, you can execute the function sooner.

TECHNICAL PARAMETERS

Power supply	2 x 1,5 V alkaline pencil-type batteries AA
Communication type	two-way
Frequency	433,92 MHz
HF output	< 10 mW
Number of temperature changes	6 different temperature changes per every day
Hysteresis	0,1 to 1,5°C in steps of 0,1°C
Minimum programmable time	10 minutes
Range of adjustable temperatures	3 to 39°C
Temperature setting	step of 0,5°C
Minimum indication step	0,1°C
Measurement accuracy	±0,5°C
Battery life	1 to 3 years according to the battery type used
Protection class	IP20
Operating temperature	0°C to +40°C

EXPLANATION OF THE PZT FUNCTION (CONST 3)

The PZT (preliminary heating switch-on) function provides for the required temperature at the required time.

Within two days, BPT-SP ascertains the room temperature constants, and then automatically switches the heating in the required advance.

The preliminary switch-on time is automatically limited to 2 hours.

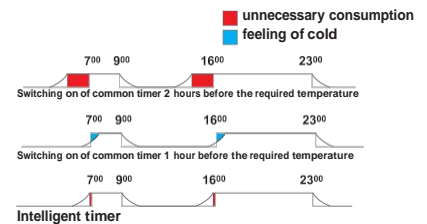

EXPLANATION OF HYSTERESIS (CONST 10)

Difference between the required and real temperature.

The hysteresis can be set in the range from 0.1 to 1.5°C. If the hysteresis is set to 1°C and the required temperature to 20°C, PH-BSP will switch off at 20°C and on again at 19 °C (see the diagram).

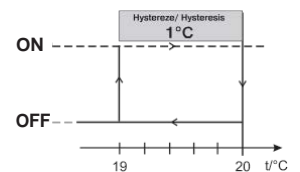

EXPLANATION OF PI REGULATION FUNCTION (CONST 11,12,13)

The PI regulation principle consists in comparison of the current room temperature with the required temperature. The Fce 11 option: when setting the time interval, heed the room thermal inertia. The optimum setting is 10-15 minutes. However, in case of frequent temperature fluctuations in the room, we recommend you to use a shorter time period. The proportional band defines the value at which the PI regulation is activated (Fce 13).

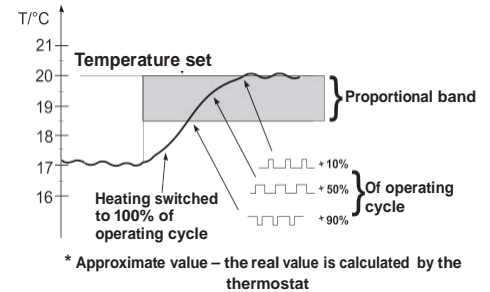
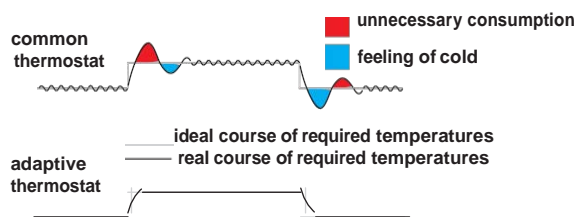

DECLARATION OF CONFORMITY

Herewith we declare that our product PH-BSP is in conformity with the basic requirements and other respective provisions of the directive 1999/5/EC.
Issued: 1.09.2008

In case of guarantee or post-guarantee service, send the unit to the reseller address.

CERTIFICATE OF GUARANTEE (guarantee period for the product amounts to 2 years)	
product No.:	date of sale:
examined by:	stamp of shop:



Llumor SCP
N-260, 18
25710 Castellciutat
T +34 973 355 504
<http://www.llumor.es>

